



# The Icon™ Back System



***Without  
Compromise***

# WHAT MAKES THE ICON™ BACK A GOOD BACK?

**Proper positioning and postural support** are essential for the health and well-being of wheelchair users: a solid back system is the key solution for proper positioning. It supports the spine and positions the pelvis. Lateral supports of the back system keep the user stable. Selecting the right solid back system is one of the most important decisions to be made when completing the setup of a wheelchair.

**For wheelchair users**, a good back offers superior positioning and comfort. It should also be easy to operate, adjust and remove, for the benefit of users who are on the go.

**For therapists**, a good back provides a variety of types and sizes to choose from in order to accommodate different seating needs. The design of the back also needs to take safety consideration into account to lower any possibility of injuries. A full range of accessories gives more options for the user.

**For technicians**, a good back is easy to install and adjust.

Built with the user, caregiver, clinician and technician in mind, the Icon™ Back System provides the best solution for those who demand comfort, simple operation and adjustment, as well as crashworthiness. The Icon™ Back System also offers a variety of back types and sizes, each with innovative adjustable hardware, plus a VARILITE air-foam floatation cushion for superior comfort.

**Superior Positioning, Comfort, Ease, Versatility, and Safety. The Icon™ Back System delivers all these benefits.**



Comfort is a user's first priority, The Icon™ Back System is designed to provide the most comfortable seating. Rollover cover, air and dual-stiffness foam cushioning, and breathable fabric are the essential elements to make it possible.

## ROLLOVER COVER

The Icon™ Back System features an innovative rollover cushion to protect the user from contact with the edge of the shell during extension or weight shifting activities. The cushion is secured inside the cover so it stays in place. Wheelchair users can perform their activities of daily living with confidence and in comfort.



## AIR AND DUAL-STIFFNESS FOAM

The Icon™ Back System incorporates a VARILITE air foam floatation cushion. Sculpted foam fits the shell contour without bunching. Multi-stiffness foam is thickest along the vertebral column. Soft foam protects the sensitive areas of the spine while firmer foam supports the sides of the trunk. A two-way air valve allows air in and out of the cushion for a custom fit and adjustable comfort.



## BREATHABLE FABRIC

Spacer knit fabric on the outside of the cover increases air-flow between the user and the back support. Reticulated foam sewn under the spacer knit fabric provides additional air exchange plus pressure distribution. The Icon™ Back System cover meets ISO 7176-16 ignition resistance standards for upholstered wheelchair components. The cover is machine washable.



# EASE OF USE

The Icon™ Back System is designed for users who are on the go. Operating the system is as easy as opening the latches and sliding the back support out of the hardware. Latches stay in an open position until the back is removed, making it simple to remove the support with one hand or for those with limited dexterity. The hardware guides the back support back into position with minimal effort and locks it securely into place. Red safety markings alert the user that a latch is open and not in the locked position.



# EASE OF INSTALLATION

The Icon™ Back System installs on a wheelchair quickly and easily. Only two parts need to be attached to the wheelchair – all other hardware components are pre-installed. All adjustment screws are the same. Only a single tool is needed.

Icon™ hardware is symmetrical so there are no right-handed or left-handed components. Symmetrical hardware provides a wide range of seat depth adjustment, without any need for special, extra length parts. Posterior seat depth can be increased or anterior depth decreased by reversing the hardware. Symmetrical hardware simplifies ordering and management of spare parts.



## INSTALLING ICON™ BACK HARDWARE ON WHEELCHAIR CANES

Icon™ Back hardware is sized to fit wheelchair canes 25mm in diameter. Shims are provided for wheelchair canes less than 25mm in diameter. Use the chart below to choose properly the appropriate sized shim to fit your cane diameter.

Cane Size	Shim Size	Included with Hardware?
22mm (7/8")	3.18mm	Yes
19mm (3/4")	6.35mm	Yes

## COUNTOUR DEPTH

Icon™ Low, Mid, and Tall Backs  
Size: 45cm (18 inch)

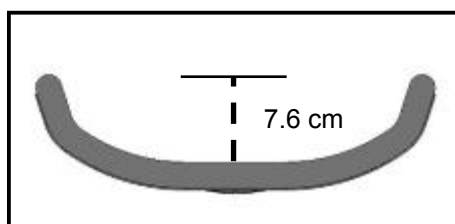

Icon™ Deep Back  
Size: 45 cm (18 inch)

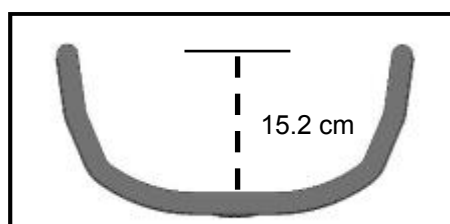

Contour depth is calculated with a fully inflated cushion. Actual depth may vary by up to 4 cm as cushion inflation is adjusted.

# EASE OF ADJUSTMENT

Adjusting the angle, width, height and depth of the Icon™ Back System hardware is simple and easy. All adjustment screws are accessible from the rear of the back support or from the outside of the upright brackets. Only one tool is needed. Adjustments can be made while the user is in the wheelchair.

Once adjusted, the Icon™ hardware stays in place. The upright brackets clamp securely and will not slip. The innovative Adjuster Plate mechanism for recline adjustment is positive locking to prevent the back support from moving during daily activities or at other times when heavy loads are placed on it.



## • ANGLE ADJUSTMENT

The Icon™ hardware allows for  $\pm 20^\circ$  of adjustment to the angle of the back.

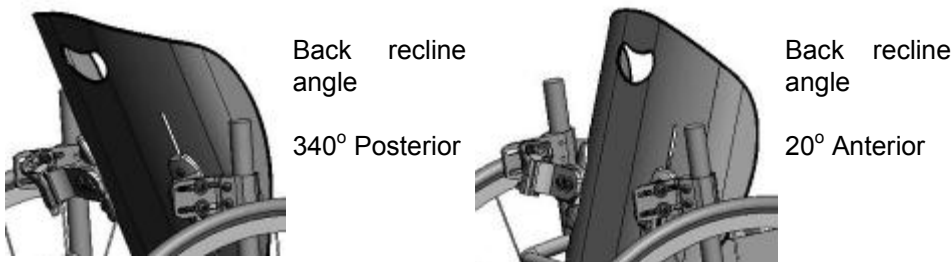

## • WIDTH ADJUSTMENT

Adjusting the lateral position is done by moving the Slide Brackets. The Slide Brackets adjust up to 1" (2.5 cm) making it possible to install on wheelchairs 1" (2.5 cm) wider or narrower than the width of the back support, or to position the Icon™ back off-centre.

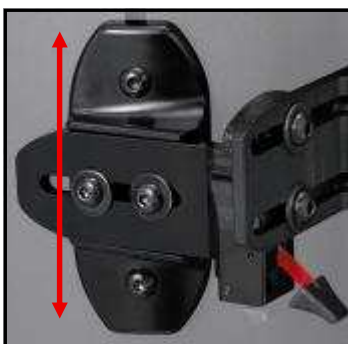
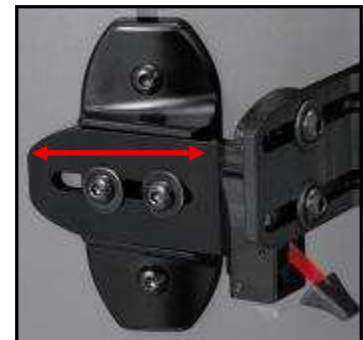

## • HEIGHT ADJUSTMENT

Moving the back up and down is as simple as loosening the Shell Brackets and sliding the back into position.

## • DEPTH ADJUSTMENT

Depth can be adjusted 1.5" (4cm) by moving the holster along the Upright Bracket.

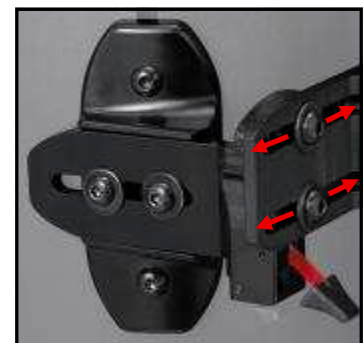

Upright Brackets Forward



Upright Bracket Rearward

## DEPTH ADJUSTMENT (continued)

The Icon™ Back System provides excellent seat depth, and allows for growth, by offering four different installation configurations. In the Basic Installation the upright brackets are in the rearward position and the slide brackets in the forward position. Changing the back to fit positioning needs is as easy as reconfiguring the position of the upright brackets and slide brackets from the Basic Installation.

- **Basic Installation**



**CONFIGURATION**

**Upright Bracket:** Posterior  
**Slide Bracket:** Anterior  
**Trunk Support Surface Range:**  
 6.1cm posterior to 2.3 cm posterior to the canes

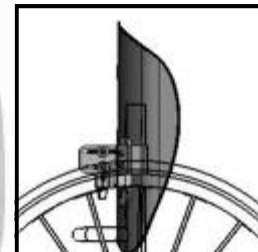

- **Extra Depth Installation**



**CONFIGURATION**

**Upright Bracket:** Posterior  
**Slide Bracket:** Posterior  
**Trunk Support Surface Range:**  
 9.9 cm posterior to 6.1 cm posterior to the canes

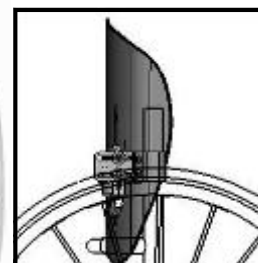

- **Growth Installation**



**CONFIGURATION**

**Upright Bracket:** Anterior  
**Slide Bracket:** Posterior  
**Trunk Support Surface Range:**  
 0.76 cm anterior to 4.6 cm anterior to the canes

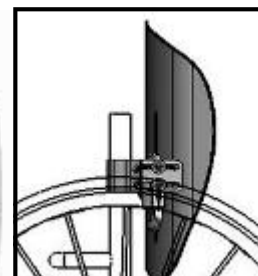

- **Extra Growth Installation**



**CONFIGURATION**

**Upright Bracket:** Anterior  
**Slide Bracket:** Posterior  
**Trunk Support Surface Range:**  
 4.6 cm anterior to 8.4 cm anterior to the canes

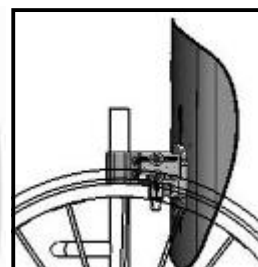

Note: altering the depth will affect the Centre of Gravity of the wheelchair set up and therefore its tipiness. It will also improve or impair the efficiency of propulsion for a self-propelled chair.

# ICON™ BACK



ICON™ LOW BACK

ICON™ MID BACK

ICON™ TALL BACK

ICON™ DEEP BACK

Cushion Composition	Air-Foam Floatation	Air-Foam Floatation	Air-Foam Floatation	Air-Foam Floatation
Shell Composition	aluminium	aluminium	aluminium	aluminium
Hardware Composition	metal	metal	metal	metal
Cover Type	spacer knit	spacer knit	spacer knit	spacer knit
Enhanced Rollover Cover				
Valve Type	standard	standard	standard	standard
Back Angle Recline	20°	20°	20°	20°
Attachment Points	two	two	two	two
Lower Trunk Positioning				
Upper Trunk Positioning				
Lateral Trunk Positioning				
Lateral Support Compatible				
Weight (18in/45cm) (Includes all hardware)	3.4 lbs (1.5kg)	4.3 lbs (1.9kg)	5.5 lbs (2.5kg)	6.4 lbs (2.9kg)
Maximum User Weight	300 lbs (136kg)	300 lbs (136kg) Bariatric Sizes 400 lbs (181kg)	300 lbs (136kg)	300 lbs (136kg)
Paediatric Sizes				
Bariatric Size				

# ICON™ LOW BACK

## PELVIC AND LUMBAR SUPPORT FOR A USER WITH GOOD TRUNK CONTROL



This support combines the Icon™ hardware features with a sleek, low profile look.

The Icon™ Low Back is an ideal lightweight solution for users needing lower trunk support and the full adjustment normally only found in a larger style of back. The upper body is unimpeded, which allows full range motion of the upper body and trunk, and for day-to-day activities. The shell curves around the sides of the body for mild lateral support, while the accompanying enhanced rollover cushion protects the user and provides maximum comfort.

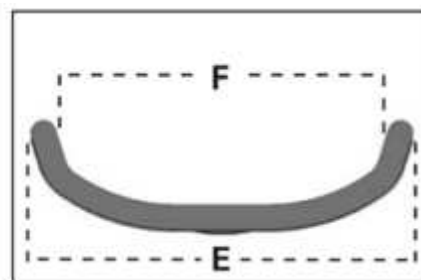
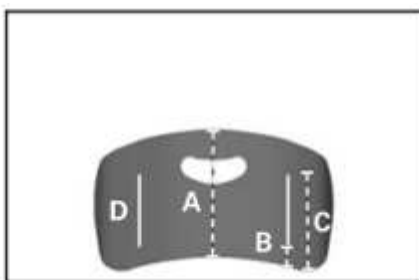

Icon™ LOW Back Size	cm Inch	35 14	38 15	40 16	43 17	45 18	50 20
<b>Part number</b>		<b>32141</b>	<b>32151</b>	<b>32161</b>	<b>32171</b>	<b>32181</b>	<b>32201</b>
A. Back Height	cm Inch	18 7.25	20 7.7	21 8.25	22 8.7	23 9.1	24 9.5
B. Bottom of back to beginning of vertical slot	cm Inch	4 1.5	4 1.5	4 1.5	4 1.5	4 1.5	4 1.5
C. Bottom of back to top of vertical slot	cm Inch	14 5.5	14 5.5	14 5.5	14 5.5	15 6.0	15 6.0
D. Range of Icon™ hardware adjustment in vertical slot	cm Inch	1 0.5	1 0.5	1 0.5	1 0.5	2 1.0	2 1.0
E. Outside width of shell	cm Inch	29 11.4	31 12.4	34 13.4	37 14.4	39 15.4	44 17.4
F. Width of support surface	cm Inch	27 10.6	29 11.6	32 12.6	35 13.6	37 14.6	42 16.6
Fits wheelchair widths	cm Inch	33-38 13-15	35-40 14-16	38-43 15-17	40-45 16-18	43-48 17-19	48-53 19-21

# ICON™ MID BACK

## MIDTHORACIC SUPPORT FOR A LARGE RANGE OF BODY TYPES

**This back provides support and positioning to improve trunk control and decrease fatigue.**

The Icon™ Mid Back supports the user to just below the scapulae so the back does not interfere with arm movement during propelling or other activities.

The Icon™ Mid Back shell provides mild lateral support. Secondary supports (pp12-13) attach easily if more aggressive lateral support is required. The back features an enhanced rollover cushion to protect the user and for added comfort.

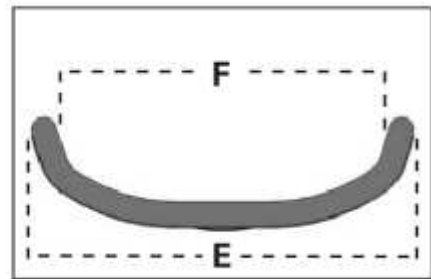
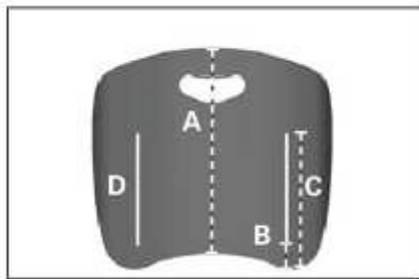

Icon™ MID Back Size	cm Inch	30 12	35 14	38 15	40 16	43 17	45 18	50 20	55 22	60 24
<b>Part number</b>		<b>12121</b>	<b>12141</b>	<b>12151</b>	<b>12161</b>	<b>12171</b>	<b>12181</b>	<b>12201</b>	<b>12221</b>	<b>12241</b>
A. Back Height	cm Inch	25 9.7	28 11.2	31 12	32 12.7	34 13.5	36 14.25	40 15.75	40 15.75	40 15.75
B. Bottom of back to beginning of vertical slot	cm Inch	3 1.3	4 1.5	4 1.5	4 1.5	4 1.5	4 1.5	4 1.5	4 1.5	4 1.5
C. Bottom of back to top of vertical slot	cm Inch	13 5.3	17 6.5	18 7.0	19 7.5	20 8.0	22 8.5	22 8.5	22 8.5	22 8.5
D. Range of Icon™ hardware adjustment in vertical slot	cm Inch	1 0.5	4 1.5	5 2.0	6 2.5	8 3.0	9 3.5	9 3.5	9 3.5	9 3.5
E. Outside width of shell	cm Inch	24 9.5	29 11.4	31 12.4	34 13.4	37 14.4	39 15.4	44 17.4	49 19.4	54 21.4
F. Width of support surface	cm Inch	22 8.7	27 10.6	29 11.6	32 12.6	35 13.6	37 14.6	42 16.6	47 18.6	52 20.6
Fits wheelchair widths	cm Inch	30-33 12-13	33-38 13-15	35-40 14-16	38-43 15-17	40-45 16-18	43-48 17-19	48-53 19-21	53-58 21-23	58-63 23-25

# ICON™ TALL BACK

## FULL THORACIC COVERAGE FOR MODERATE TO MAXIMUM SUPPORT



This back is well suited for those needing additional support, or using a tilt and recline system.

The Icon™ Tall Back supports the back to the top of the shoulders, including the scapulae, which is ideal for users with decreased trunk control. The curved shell provides moderate back support. Lateral supports (pp12-13) can be easily mounted using existing vertical shell slots. Head rests can be installed onto the aluminium shell for more positioning options.

This and the Icon™ Deep Back have met the requirement of the ISO 16840-4 Crashworthiness test.

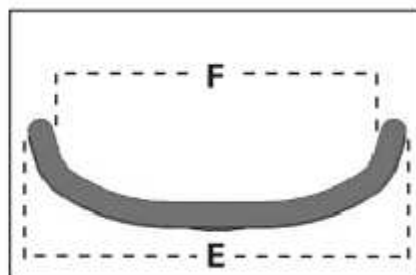
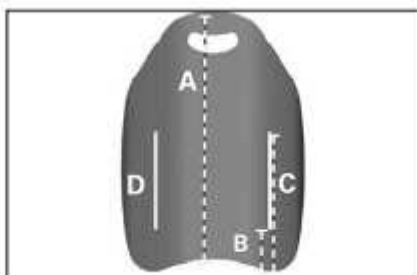

Icon™ TALL Back Size	cm Inch	30 12	35 14	38 15	40 16	43 17	45 18	50 20
Part number		22121	22141	22151	22161	22171	22181	22201
A. Back Height	cm Inch	37 14.6	43 17.0	46 18.2	49 19.4	52 20.5	55 21.75	60 23.6
B. Bottom of back to beginning of vertical slot	cm Inch	5 2.0	6 2.5	6 2.5	8 3.0	8 3.0	9 3.5	9 3.5
C. Bottom of back to top of vertical slot	cm Inch	23 9.0	24 9.5	27 10.5	28 11.0	28 11.0	29 11.5	29 11.5
D. Range of Icon™ hardware adjustment in vertical slot	cm Inch	9 3.5	9 3.5	11 4.5	11 4.5	11 4.5	11 4.5	11 4.5
E. Outside width of shell	cm Inch	24 9.5	29 11.4	31 12.4	34 13.4	37 14.4	39 15.4	44 17.4
F. Width of support surface	cm Inch	22 8.7	29 10.6	31 11.6	34 12.6	37 13.6	39 14.6	44 16.6
Fits wheelchair widths	cm Inch	30-33 12-13	33-38 13-15	35-40 14-16	38-43 15-17	40-45 16-18	43-48 17-19	48-53 19-21

# ICON™ DEEP BACK

## FULL THORACIC COVERAGE AND DEEP LATERAL SUPPORT

**This back is ideal for users needing maximum support.**

The Icon™ Deep Back supports a user's back to the top of the shoulder, including the scapulae, with extra lateral support of the thoracic trunk. The deep contour of the back provides more lateral support for users with poor trunk control. Head rests and other secondary supports can be installed onto the aluminium shell. The Icon™ Deep Back includes a closed-cell foam PSIS (posterior superior iliac spine) block and Supplemental Lateral Pads that attach to the shell with adhesive hook and loop. The PSIS block provides support to the pelvis at the PSIS level, promoting anterior pelvic tilt and spinal extension. The Supplemental Lateral Pads help customize the fit.

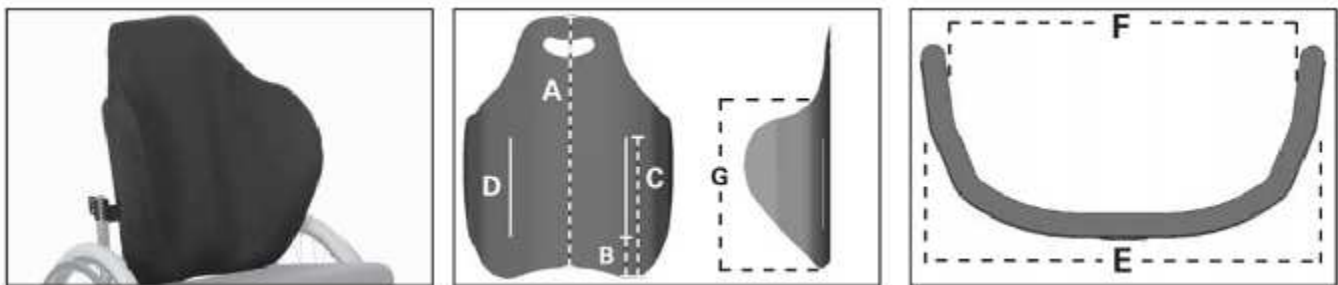

Icon™ DEEP Back Size	cm	35	38	40	43	45	50
	Inch	14	15	16	17	18	20
<b>Part number</b>		<b>42141</b>	<b>42151</b>	<b>42161</b>	<b>42171</b>	<b>42181</b>	<b>42201</b>
A. Back Height	cm Inch	43 17.0	46 18.2	49 19.4	52 20.5	55 21.75	60 23.6
B. Bottom of back to beginning of vertical slot	cm Inch	6 2.5	6 2.5	8 3.0	8 3.0	9 3.5	9 3.5
C. Bottom of back to top of vertical slot	cm Inch	24 9.5	27 10.5	28 11.0	28 11.0	29 11.5	29 11.5
D. Range of Icon™ hardware adjustment in vertical slot	cm Inch	9 3.5	11 4.5	11 4.5	11 4.5	11 4.5	11 4.5
E. Outside width of shell	cm Inch	32 12.6	36 14.3	39 15.3	41 16.3	44 17.4	50 19.6
F. Width of support surface	cm Inch	30 11.8	34 13.5	37 14.5	39 15.5	42 16.6	48 18.8
G. Height of fixed lateral support	cm Inch	29 11.6	32 12.6	35 13.6	36 14.3	38 15.0	41 16.2
Fits the same wheelchair widths as the Icon™ Tall Back							

# SAFETY

## CRASHWORTHINESS

VARILITE™ supports industry safety initiatives. The Icon™ Back Systems have been dynamically tested for safe use in motor vehicles by an independent transportation centre. The Icon™ Tall Back and Icon™ Deep Back have been tested and conform with ISO 16840-4 for the safe use of seating devices for use in motor vehicles when used with a wheelchair base that complies with the performance requirements of ISO 7176-19.

For more information about the safe use of wheelchairs in a motor vehicle, please visit [www.varilite.com](http://www.varilite.com) to download the RideSafe Brochure.

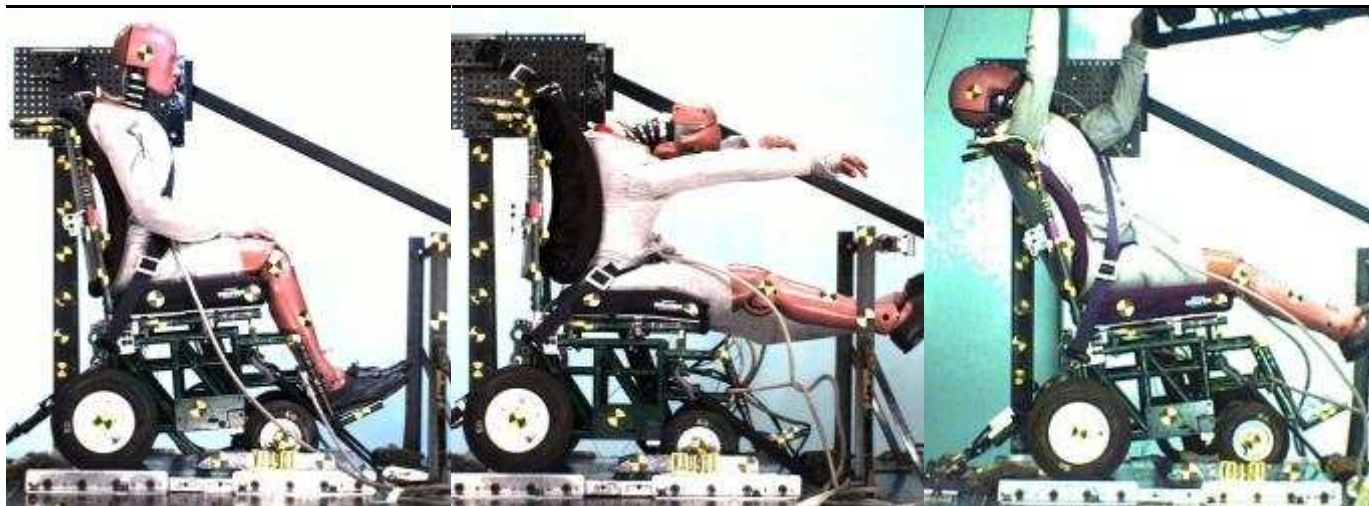

**Note:** Because the heights of the Icon™ Low Back and the Icon™ Mid Back do not offer proper head support for safe use in a motor vehicle, these models have not been dynamically tested.

## SAFETY LATCHES

Icon™ Back System latches open outward to prevent unintentional activation by contact with backpacks or items. Red safety markings alert the user or caregiver that a latch is open. Icon latches lock securely when the back support is inserted.



## RESISTANCE TO FLAMMABILITY

Flammability testing has been performed on the Icon™ Back System cushions and covers by an independent laboratory according to the requirements of ISO 7176-16 standard for resistance to ignition of wheelchair-upholstered parts. The ISO standard specifies methods of testing to assess the resistance of the cover and cushion to ignition by cigarette or match. The standard specifies requirements that progressive smouldering ignition and flaming resistance shall not occur. Icon™ Back System cushions and covers meet the ISO 7176-16 standard.

Please follow the 4-steps process on the next two pages

## 1. CHOOSE EITHER A PAL SWING-AWAY OR A FIXED LATERAL SUPPORT

### • PAL™ Swing-Away Lateral Support

The VARILITE PAL™ Swing-Away Thoracic supports are designed to complement the Icon™ Mid and Icon™ Tall backs. PAL (Positive Action Lateral) supports allow hinge angle, pad rotation, and horizontal pad adjustments for a precise fit. All PAL™ swing-away lateral supports include a neoprene cover that attaches easily to the PAL™ push button hinge.

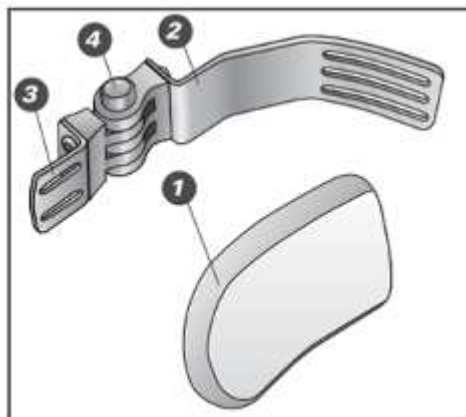

#### 1. Pad:

Pads are available in contoured or linear styles, in three sizes (see p13). They are made of closed-cell foam with a steel insert that allows horizontal pad adjustment. The pad foam is protected with a removable, machine washable cover.

#### 2. Shell Bracket:

Constructed of steel, the shell bracket is contoured to mount on the inside of a VARILITE Icon™ Mid Back or Tall Back shell. The low profile bracket is less than 1/8" thick.

#### 3. Pad Bracket:

Constructed of steel for strength, the pad bracket attaches securely to the pad. Easy adjustment allows +/- 10° of vertical pad rotation. Pad brackets are available in short, long, and offset sizes.

#### 4. Push Button Hinge:

An easily activated push button unlocks the PAL™ swing-away hinge mechanism. Positive Locking Action indicates when the hinge is securely locked. Easy hinge angle adjustment provides up to 225° of swing.

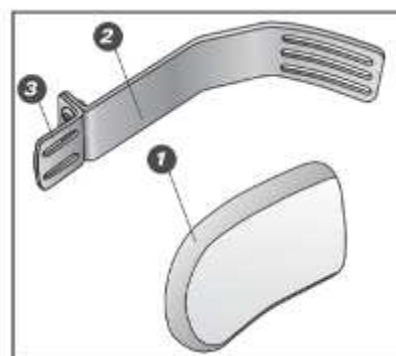
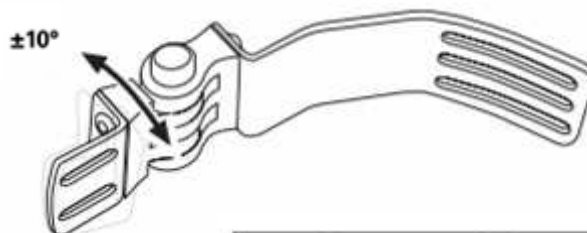
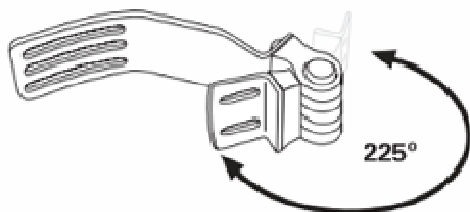

### • Fixed Lateral Support

Fixed lateral supports are available for situations when a swing-away lateral is not required. Fixed lateral supports consist of shell bracket, pad bracket, and pad.

1. Pad
2. Shell Bracket
3. Pad Bracket

## 2. SELECT TYPE OF BRACKET

- PAL™ Swing-Away Lateral**

Pad Bracket	Short	Long	Short w/2 cm Offset
Horizontal Pad Adjustment:	2.5cm	5.7cm	2.5cm
Fits Icon Mid and Tall Backs System Size:	Part Number		
30cm	89050	89150	89250
35-38cm	89010	89110	89210
40-43cm	89020	89120	89220
45cm	89030	89130	89230
50-60cm	89040	89140	89240

- Fixed Lateral Support**

Pad Bracket	Long
Horizontal Pad Adjustment:	5.7cm
Fits Icon Back System Size:	Part Number
30cm	89050
35-38cm	89010
40-43cm	89020
45cm	89030
50-60cm	89040

## 3. SELECT TYPE AND SIZE OF PAD

- Curved Pads**

Dimensions W x L	Part Number
7.5 x 10 cm	04317
10 x 13 cm	04319
13 x 15 cm	04321

- Linear Pads**

Dimensions W x L	Part Number
7.5 x 10 cm	04307
10 x 13 cm	04309
13 x 15 cm	04311

## 4. INSTALLATION OF HEAD AND LATERAL SUPPORTS ON ICON BACK

VARILITE PAL™ Swing-Away fixed or lateral thoracic supports may be installed using the slots provided on the back shell. To install head supports or place lateral supports in alternative locations, the aluminium shell may be drilled without voiding the warranty.

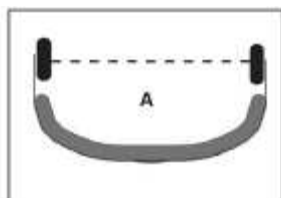

**MEASURED AT THE WIDEST POINT**

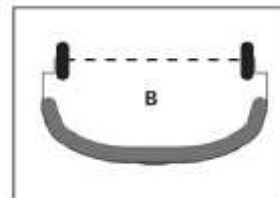

Icon™ Mid Back and Icon™ Tall Back	30 cm	35 cm	38 cm	40 cm	43 cm	45 cm	50 cm	55 cm	60 cm
A. Short and Long brackets width between pads	19 cm	24 cm	26 cm	29 cm	32 cm	34 cm	39 cm	44 cm	49 cm
B. Offset bracket width between pads	17 cm	21 cm	24 cm	26 cm	29 cm	32 cm	37 cm	42 cm	47 cm

## ADDITIONAL EXTRAS

Users who need extra support for correct positioning can utilize the PSIS Block or Supplemental Lateral Supports attached to the shell of their Icon™ Back System. These supports are integrated into the shell of the Icon™ Deep Back, and can be moved throughout the shell using hook and loop attachments. The PSIS Block and Supplemental Lateral Supports can be added as accessories to any VARILITE™ back system.

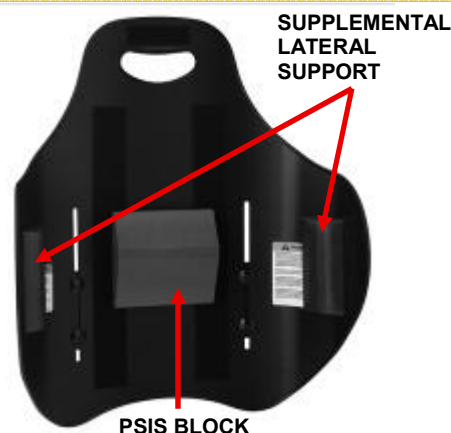

### PSIS BLOCK (Part No. 04249)



The PSIS (posterior superior iliac spine) block provides support to the sacrum at the PSIS level, promoting neutral pelvic tilt and spinal extension.

### SUPPLEMENTAL LATERAL SUPPORT (Part No. 04266)



Provides additional support where desired when placed inside the Icon™ Back Shell. The Supplemental Lateral Pads help users who lean to one side to maintain an upright position, and are especially beneficial for older clients.

## CUSHIONS AND COVERS

Users needing a backup cushion or cover can purchase the washable spacer knit fabric cover and air-foam cushion separately from the back system. Covers can be purchased as a single item, or with the cushion. Cushions are covered by the 2 year warranty, and covers for one year.

Icon Low Back			Icon Mid Back			Icon Tall Back			Icon Deep Back		
Size (cm)	Cushion	Cover	Size (cm)	Cushion	Cover	Size (cm)	Cushion	Cover	Size (cm)	Cushion	Cover
	Item No.	Item No.		Item No.	Item No.		Item No.	Item No.		Item No.	Item No.
35	07140	07168	30	07146	07174	30	07155	07183	35	07162	07190
38	07141	07169	35	07147	07175	35	07156	07184	38	07163	07191
40	07142	07170	38	07148	07156	38	07157	07185	40	07164	07192
43	07143	07171	40	07149	07177	40	07158	07186	43	07165	07193
45	07144	07172	43	07150	07178	43	07159	07187	45	07166	07194
50	07145	07173	45	07151	07179	45	07160	07188	50	07167	07195
			50	07152	07180	50	07161	07189			
			55	07153	07181						
			60	07154	07182						

### MODESTY KITS (Part No. 95-706)

Users needing extra coverage between the back support and wheelchair seat can purchase a modesty kit that attaches to the shell of the back system and the seat of the wheelchair. Modesty kits provide draft exclusion for the user, while appearing integrated into the back support.



## TERMS AND CONDITIONS OF SALE

### WARRANTY

All VARILITE™ products have been carefully inspected prior to shipping. All cushions and covers have been marked with serial numbers that correlate to a specific history of materials and workmanship. All products are warranted against manufacturer's defects for two years from the original date of purchase with the exclusion of covers which are warranted for one year. This warranty is limited to the repair or replacement of components and does not cover incidental or consequential damages. This warranty is only valid for the original purchaser of the product. Should a product be found defective under this warranty, we will repair it or replace it, at our option, free of charge. Alteration of the components, abuse (punctures, cuts, burns or abrasions), misapplication, normal wear, or failure to close the valve are not included, nor is the cover included. If a returned component is considered damaged due to alteration, abuse, or normal wear, you will be contacted. If a problem arises with your VARILITE™ product, please call us, For a return under warranty, you will need a Return Authorization number.

### STOCK RETURNS

Please contact BES Rehab Ltd within 30 days of the purchase date for a return authorization number. All stock returns are subject to a 15% restocking fee, plus applicable freight charges.

### CLAIMS

Invoices are dispatched separately at the same time as the goods. All claims for non-receipt are to be made within seven days of invoice date.

### PAST DUE ACCOUNTS

Past due invoices will incur finance charges of 10% late payment surcharge and interest of 3% per month or part of month

### TERMS

Please note that all prices quoted are exclusive of

- Carriage
- VAT
- Consultancy charges
- Fitting charges



Contact BES Rehab Ltd now to place an order or request more information:

**Tel: 0845 1300 237**  
**Fax: 0845 1300 238**  
**Email: [info@besbiz.eu.com](mailto:info@besbiz.eu.com)**



BES Rehab Ltd  
131 South Liberty Lane  
Ashton Vale  
Bristol  
BS3 2SZ  
**[www.besbiz.eu.com](http://www.besbiz.eu.com)**

